

Tilt N Space Script

Tilting Frame Wheelchair 90600



To Order Fill in the frame dimensions and features required. For variations describe in detail on a separate page. If you have any further questions contact us at the address at the bottom of the page.

SEND FORM
If online, click here to send via e-mail

Date _____

Name _____

Address _____

Phone _____

Fax / Cell _____

Email _____

Delivery details _____

Therapist details _____

Required by _____

Disability _____ Weight _____ Height _____ Shoe Size _____ T-Shirt Size _____
(Weight limit is 110kg for standard option, weights in excess of this incur an upcharge for reinforcing requirements)

TRIAL CHAIR REF: _____

MEASUREMENTS (Refer to diagram)

A Seat width _____

B Seat depth 15" - 20" 17" - 22"
if known set initial length at: _____

C Camber 0° 3° _____

D Back canes height standard 21.5"
if known set height at: _____

E Seat to footplate _____

F Wheelchair height adjustable (depends on wheel size) _____

Additional Notes
(you can type here)

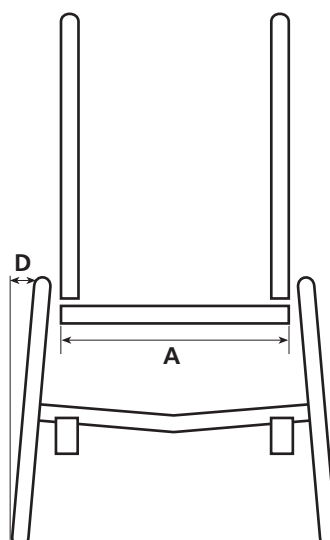
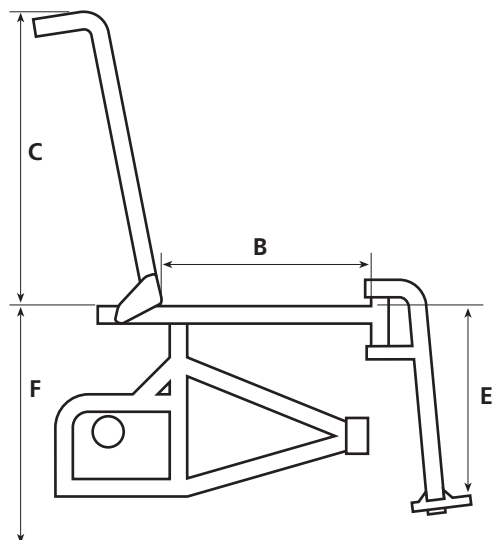

Tilt N Space Script

Tilting Frame Wheelchair

Name _____

BACK CANES

- Standard fixed pole with push handles
- Adjustable height: (range) _____
- Extension stroller handle (removable)

FOOT-PLATE STYLE

- Swing away with flip up foot-rest - 60° hanger
- Swing away with flip up foot-rest - 70° hanger
- Swing away with flip up foot-rest - 80° hanger
- Swing away with flip up foot-rest - 90° hanger
- Drop in one piece - 60° hanger
- Drop in one piece - 70° hanger
- Drop in one piece - 80° hanger
- Drop in one piece - 90° hanger
- Clamp on dual foot-plate - 90° hanger

FOOT-PLATE

- Plastic (std) Angle adjustable

Drop in foot-plate only

- Fabric cover ABS on foot-plate

CASTORS

- 5" solid (std) 5" x 1.5 solid
- 5" solid, alloy rim 5" x 1.5" alloy rim
- 6" solid 6" x 1.5" solid
- 6" solid, alloy rim 6" x 1.5" alloy rim
- 6" pneumatic 8" pneumatic
- Other _____

FORKS

- Standard forks

AXLES

- Quick release axles

PUSH-RIMS (on 20" 22" 24" wheels only)

- Nil Hard anodised (std)
- Vinyl covered Foam covered
- Rubber covered (black) Rubber covered (red)

PUSH-RIMS - POSITION

- Standard In close Onto rim

SPOKE GUARDS

- Nil Clear Black

BRAKES

- Nil Push to lock (std)
- Drum brakes (not on 12") Foot brakes (on 12" only)

ANTI-TIPS

- Nil
- Pair of singles with plastic wheels (std)
- Pair of singles with roller-blades

ARMRESTS

- Nil
- T Adjustable height with desk pad
- T Adjustable height with full length pad
- ABS skirt guard on armrest

ACCESSORIES

- Tray Heel loops
- Seat belt Ankle huggers
- Positioning belt Leg strap
- 5 point body harness Impact guards
- Back pack

SEATING

- Plywood base Alloy Base



















Other seating options available (contact us)

WHEELS

- 12 x 2 1/4 composite wheel with tread tyres
- 16 x 1 3/4 composite wheel with tread tyres
- 18 x 1 3/4 composite wheel with tread tyres
- 20 x 1 3/8 composite wheel with tread tyres
- 24 x 1 3/8 composite wheel with tread tyres
- 24 x 1 cross spoked wheel with smooth tyres
- 24 x 1 cross spoked wheel with tread tyres
- 24 x 1 cross spoked wheel with solid smooth tyres
- 24 x 1.75 cross spoked wheel with BMX tyres
- Other _____

Name _____

COLOURS

- 27 Candy Blue 
- 1 Royal Blue 
- 72 Glass Blue 
- 16 Candy Purple 
- 48 Burgundy 
- 83 Candy Raspberry 
- 88 Fluro Pink 
- 28 Candy Red 
- 11 Flame 
- 57 Super Hot Chilli 
- 80 Candy Orange 
- 71 Pure Orange 
- 68 Crystal Yellow 
- 73 Crystal Jade 
- 89 Fluro Green 
- 70 Candy Emerald 
- 2 Hawthorn Green 
- 17 Crystal Sapphire 

ATTENTION









THIS IS A GUIDE TO COLOURS ONLY, how colours appear on your monitor or when printed out may vary.

Contact us if you require assistance or a colour sample.

This colour selection is for our aluminum frames only.

We do not recommend powder coating titanium.

Colour availability is subject to change without notice, contact us if you are concerned about the availability of your colour.

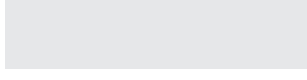
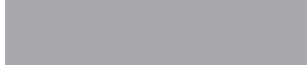
- 55 Silver Sparkle 
- 12 Silver Orbiter 
- 46 Chrome 
- 42 Metallic Viper 
- 30 Satin Black 
- 61 High Gloss Black 
- 62 Matt Black 
- 63 Texture Matt Black 
- 18 Clear 
- Bead Blast** (titanium only) 

Custom Colour (additional cost)

Description