

Piranha Script Form

Fixed Frame Wheelchair **90400**



CLIENT DETAILS	Date:
Name:	
Address:	
Phone / Mobile:	
Email:	

Funder:
Therapist:
Contact Ph:
Email:
Delivery Details:

Disability:	Trial Serial No.:
Weight: (actual) <input type="checkbox"/> <60kg <input type="checkbox"/> 60-100kg <input type="checkbox"/> >100kg	Height: Shoe Size: T-Shirt Size:

FABRICATION INFORMATION

Include details of any Power Adds and or front wheel/Freewheel
(If necessary include diagrams and additional pages)

Melrose Consultant / Dealer:

Chair Serial No.:
Date Ordered:
Date Required:

Script checked and approved for build:	Date:
Name:	Signature:

Piranha Script Form

Fixed Frame Wheelchair

90400



Client Name: _____

Chair Serial No.: _____

MEASUREMENTS (Refer to diagrams)

Frame: Titanium 90400T Aluminium 90400

A	Seat Width
B	Seat Length <input type="checkbox"/> Growth in Seat Length AD10700 (extends at rear) <input type="checkbox"/> 3/4 <input type="checkbox"/> 1-1/2 <input type="checkbox"/> 2-1/4 <input type="checkbox"/> 3
C1	Back Height <input type="checkbox"/> Fixed <input type="checkbox"/> Adjustable - Height Back Rest Style <input type="checkbox"/> Fixed <input type="checkbox"/> Folding <input type="checkbox"/> Folding/Locking AD11250
D	Back Angle°
E	Seat to Footplate <input type="checkbox"/> Fixed <input type="checkbox"/> Adjustable - Position
G	Frame Length
G1	Balance Point (COG)
H	Seat to Floor - Front
H1	Seat to Floor - Rear
I	Castor Pivot Centres
I1	Castor Pivot Position
J1	Footplate Width
K	Between Wheels
L	Camber <input type="checkbox"/> 0° <input type="checkbox"/> 1° <input type="checkbox"/> 2° <input type="checkbox"/> 3° <input type="checkbox"/> 4° <input type="checkbox"/> 5° Camber Bar Position <input type="checkbox"/> Fixed <input type="checkbox"/> Adjustable - Position Front Hanger Style <input type="checkbox"/> V Front <input type="checkbox"/> Pro T Front <input type="checkbox"/> Rolled Bottom Rail Option <input type="checkbox"/> Ergo Seat Option AD10220
M	Ergo Seat Length
M1	Ergo Back Height
M2	Ergo Back Angle°
	Pivots <input type="checkbox"/> STD <input type="checkbox"/> BULLET

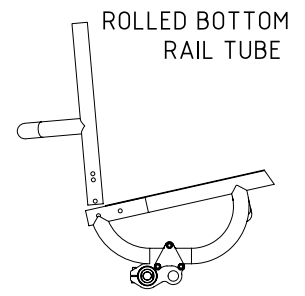
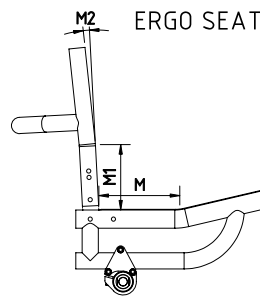
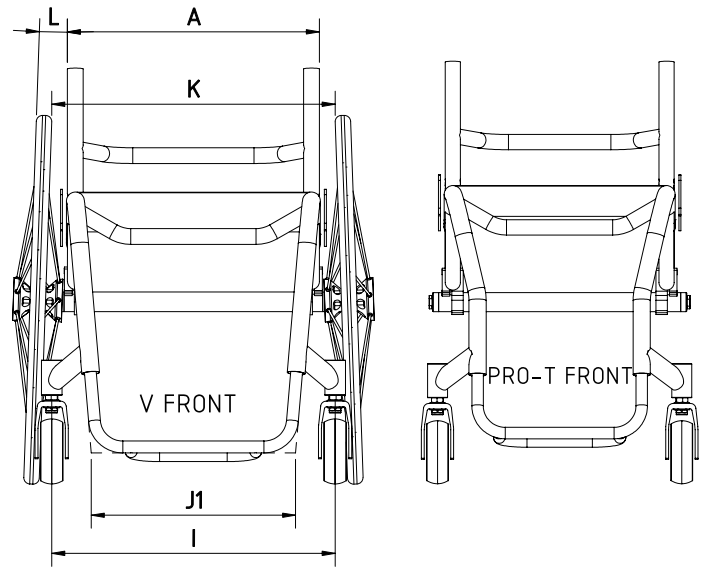
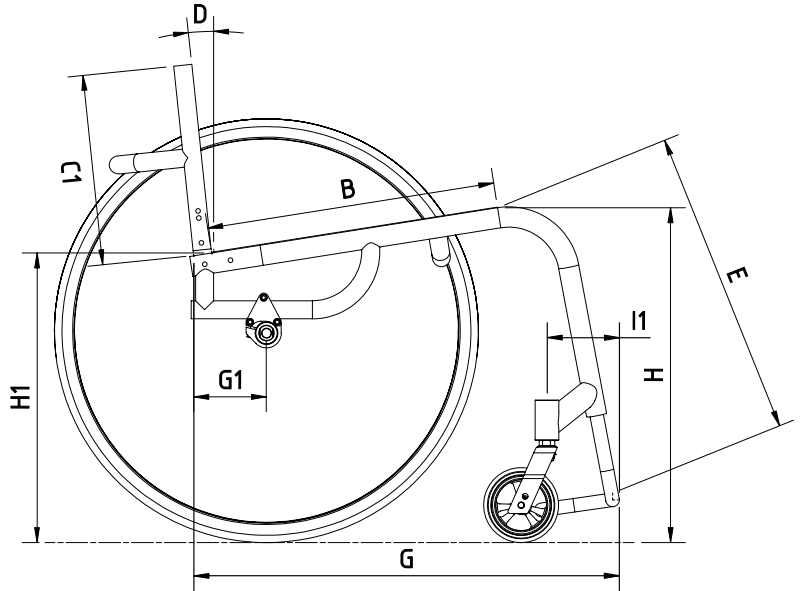

Piranha Script Form

Fixed Frame Wheelchair 90400

Client Name: _____

Chair Serial No.: _____

FOOTPLATE	
<input type="checkbox"/> Standard	Std
<input type="checkbox"/> Angle adjustable	AD11520
<input type="checkbox"/> ABS on footplate	AD11500
<input type="checkbox"/> Fabric padded cover	AD11510
<input type="checkbox"/> Carbon Fibre cover	AD11506
<input type="checkbox"/> ABS with sides	AD11505
<input type="checkbox"/> Custom:	

CASTORS	
<input type="checkbox"/> 3" Rollerblade	Std
<input type="checkbox"/> 4" x 1.25" wide solid composite	Std
<input type="checkbox"/> 5" x 1" solid composite	Std
<input type="checkbox"/> 6" x 1" solid composite	Std
<input type="checkbox"/> 3" x 1.5" alloy soft roll	AD11800
<input type="checkbox"/> 4" x 1.25" wide alloy	AD11710
<input type="checkbox"/> 4" x 1.5" alloy soft roll	AD11806
<input type="checkbox"/> 5" x 1" alloy	AD11740
<input type="checkbox"/> 5" x 1.5" wide solid composite	AD11720
<input type="checkbox"/> 5" x 1.5" wide alloy	AD11721
<input type="checkbox"/> 5" x 1.5" alloy soft roll	AD11810
<input type="checkbox"/> 6" x 1" alloy	AD11741
<input type="checkbox"/> 6" x 1.5" wide solid composite	AD11730
<input type="checkbox"/> 6" x 1.5" wide alloy	AD11742
<input type="checkbox"/> 6" x 1.5" alloy soft roll	AD11820
<input type="checkbox"/> 6" pneumatic	AD11750
<input type="checkbox"/> Custom:	

FORKS	
<input type="checkbox"/> Standard forks - black (for std pivots only)	Std
<input type="checkbox"/> Ultralight bearing forks (for bullet pivots only)	AD11910
<input type="checkbox"/> Frog Legs suspension	AD11950
<input type="checkbox"/> Frog Legs Unitine	AD11920
<input type="checkbox"/> Custom:	

BRAKES	
<input type="checkbox"/> Nil	
<input type="checkbox"/> Push to lock <input type="checkbox"/> Reverse handles	Std
<input type="checkbox"/> Scissor	Std
<input type="checkbox"/> Melrose L scissor	AD14522
<input type="checkbox"/> Melrose L scissor w/spring	AD14524
<input type="checkbox"/> Pull to lock	AD14510
<input type="checkbox"/> Hill climbers	AD14530
<input type="checkbox"/> Push to lock composite	AD14571
<input type="checkbox"/> Scissor lock composite	AD14570
<input type="checkbox"/> Eagle scissor <input type="checkbox"/> Black <input type="checkbox"/> Red <input type="checkbox"/> Blue	AD14573
<input type="checkbox"/> Superlock push to lock with brake extensions	AD14560
<input type="checkbox"/> D's locks	AD14600

BRAKES	
<input type="checkbox"/> Brake extensions <input type="checkbox"/> Left only <input type="checkbox"/> Right only	AD14550
<input type="checkbox"/> Custom:	

PUSH HANDLES	
<input type="checkbox"/> Nil	
<input type="checkbox"/> Height adj dual clamp	AD14120
<input type="checkbox"/> Foldable composite	AD14160
<input type="checkbox"/> Fold down alloy, with rubber grip	AD14161
<input type="checkbox"/> Fold down alloy, snaplock	AD14162
<input type="checkbox"/> In back canes	AD14140
<input type="checkbox"/> Removable on grab bar	AD14100
PUSH HANDLE(S) SET AT HEIGHT:	
<input type="checkbox"/> Custom:	

ANTI TIPS	
<input type="checkbox"/> Nil	
<input type="checkbox"/> Plastic wheels	AD15000
<input type="checkbox"/> Stainless steel with plastic wheels	AD15025
<input type="checkbox"/> Rollerblades	AD15030
<input type="checkbox"/> Stainless steel with rollerblades	AD15026
<input type="checkbox"/> Latch flip up	AD15022
<input type="checkbox"/> Single centre mount with plastic wheel	AD15070
<input type="checkbox"/> Single centre mount with roller blade	AD15080
<input type="checkbox"/> Double mount one piece swivel anti tip with rollerblade	AD15150
<input type="checkbox"/> Custom:	

ARMRESTS	
<input type="checkbox"/> Nil	
<input type="checkbox"/> T height adjustable desk pad armrest	AD15260
<input type="checkbox"/> T height adjustable full length pad armrest	AD15261
<input type="checkbox"/> T height adjustable desk pad armrest with ABS skirt guard	AD15280
<input type="checkbox"/> T height adjustable full length pad armrest with ABS skirt guard	AD15281
<input type="checkbox"/> Flip back, foam tube on back cane	AD15225
ARMRESTS SET AT HEIGHT:	
<input type="checkbox"/> Custom:	

Piranha Script Form

Fixed Frame Wheelchair 90400

Client Name: _____

Chair Serial No.: _____

SKIRT GUARDS

NOTE: Folding Skirt Guards Limit Brake Options *

<input type="checkbox"/>	Nil	
<input type="checkbox"/>	Fabric skirt guards	AD16100
<input type="checkbox"/>	ABS fabric covered	AD16120
<input type="checkbox"/>	ABS drop in	AD16110
<input type="checkbox"/>	Carbon fibre drop in	AD16162
<input type="checkbox"/>	Alloy fixed	AD16130
<input type="checkbox"/>	Alloy folding	AD16140
<input type="checkbox"/>	Carbon fibre fixed	AD16161
<input type="checkbox"/>	Carbon fibre folding with back *	AD16160
<input type="checkbox"/>	Carbon fibre slotted folding (through)	AD16158
<input type="checkbox"/>	Carbon fibre fold in (on to sling)	AD16172
<input type="checkbox"/>	Carbon fibre flip back	AD16174
<input type="checkbox"/>	Alloy flip back	AD16141
<input type="checkbox"/>	Carbon fibre drop in fenders	AD16163
<input type="checkbox"/>	Alloy drop in mud guard	AD16164
SKIRT GUARDS SET AT HEIGHT:		
<input type="checkbox"/>	Custom:	

UPHOLSTERY - Seating

<input type="checkbox"/>	Sling - hybrid	Std
<input type="checkbox"/>	Sling - screwed down	Std
<input type="checkbox"/>	Sling - full straps	Std
Sling Velcro: <input type="checkbox"/> Hook <input type="checkbox"/> Loop		
<input type="checkbox"/>	Solid alloy base	AD18030
<input type="checkbox"/>	Solid carbon base	AD18031
<input type="checkbox"/>	Tension adjustable back	AD16010
<input type="checkbox"/>	Standard back	Std
<input type="checkbox"/>	No back upholstery	
<input type="checkbox"/>	To fit solid back:	
<input type="checkbox"/>	Cushion 1"	AD16201
<input type="checkbox"/>	Cushion 2"	AD16202
<input type="checkbox"/>	Cushion 3"	AD16203
<input type="checkbox"/>	Custom:	

UPHOLSTERY - Bags

<input type="checkbox"/>	Bag on front hanger - left	AD16620
<input type="checkbox"/>	Bag on front hanger - right	AD16620
<input type="checkbox"/>	Bag on back of chair	AD16680
<input type="checkbox"/>	Bag under chair	AD16600
<input type="checkbox"/>	Bag under chair - Net	AD16650
<input type="checkbox"/>	Bag under chair - quick release, small	AD16601
<input type="checkbox"/>	Wallet / phone holder	AD16622
<input type="checkbox"/>	Drink bottle holder	AD16624
<input type="checkbox"/>	Custom:	

UPHOLSTERY - Leg Supports

<input type="checkbox"/>	Leg strap	Std
<input type="checkbox"/>	Padded calf strap	AD16320
<input type="checkbox"/>	Body Point calf strap - Size:	

UPHOLSTERY - Impact Guards

(Impact guards made only if suitable after fitting anti tips, push handles etc.)

<input type="checkbox"/>	Front hanger impact guards - Webbing Fabric	AD16400
<input type="checkbox"/>	Front hanger impact guards - Neoprene	AD16401
<input type="checkbox"/>	Front hanger impact guards - Leather	AD16402
<input type="checkbox"/>	Grab bar impact guards	AD16420
<input type="checkbox"/>	Bottom bar impact guards	AD16422

SEAT BELT

<input type="checkbox"/>	Car buckle	AD16522
<input type="checkbox"/>	Plastic buckle	AD16500
<input type="checkbox"/>	Body Point - Size/Style:	

FRAME COLOURS - For Titanium frames

Beadblast
StdPolished
AD10120

(Powder coat colours are not recommended on Titanium frames - look at the Colour Chart on page 6 for Aluminium frame colours)

Piranha Script Form

Fixed Frame Wheelchair 90400

Client Name: _____

Chair Serial No.: _____

STANDARD REAR WHEELS (for BMX - see Spare Wheels)

		22	24	25	26
Spoked	Std	<input type="checkbox"/>	<input type="checkbox"/>	<input type="checkbox"/>	<input type="checkbox"/>

PERFORMANCE REAR WHEELS

		22	24	25	26
Spinergy L Spox (18 spoke)	AD13300		<input type="checkbox"/>	<input type="checkbox"/>	<input type="checkbox"/>
Spinergy LX Lite (12 spoke)	AD13310	<input type="checkbox"/>	<input type="checkbox"/>	<input type="checkbox"/>	<input type="checkbox"/>
Spinergy LX with FlexRim (black only)	AD13315		<input type="checkbox"/>	<input type="checkbox"/>	
Spinergy XLX (12 spoke cross laced)	AD13312		<input type="checkbox"/>	<input type="checkbox"/>	<input type="checkbox"/>
Spinergy Blade (18 spoke)	AD13313	<input type="checkbox"/>	<input type="checkbox"/>	<input type="checkbox"/>	<input type="checkbox"/>
Spinergy Carbon CLX (18 spoke)	AD13318		<input type="checkbox"/>	<input type="checkbox"/>	
Spinergy Sport SLX (24 spoke large hub heavy duty - black only)	AD13420		<input type="checkbox"/>	<input type="checkbox"/>	<input type="checkbox"/>
Spinergy Sport XSLX (24 spoke cross laced - black only)	AD13314		<input type="checkbox"/>	<input type="checkbox"/>	<input type="checkbox"/>
Custom wheel (specify below)		<input type="checkbox"/>	<input type="checkbox"/>	<input type="checkbox"/>	<input type="checkbox"/>
-					

SPINERGY SPOKE COLOUR (Optional)

(Colour spokes not available on Carbon, Sports and FlexRim wheels)

Spinergy L Spox	<input type="checkbox"/> Black	<input type="checkbox"/> Red	<input type="checkbox"/> Blue	<input type="checkbox"/> White	<input type="checkbox"/> Yellow
Spinergy LX, Spinergy Blade	<input type="checkbox"/> Black	<input type="checkbox"/> Red	<input type="checkbox"/> Blue	<input type="checkbox"/> White	<input type="checkbox"/> Yellow
	<input type="checkbox"/> Green	<input type="checkbox"/> Purple	<input type="checkbox"/> Pink	<input type="checkbox"/> Orange	
Custom -					

AXLES

<input type="checkbox"/> Quick Release	Std	
<input type="checkbox"/> Quad Release	AD12500	

TYRES

		22	24	25	26
1" HP Smooth	Std	<input type="checkbox"/>	<input type="checkbox"/>	<input type="checkbox"/>	<input type="checkbox"/>
1" HP Tread	Std		<input type="checkbox"/>		
1" Solid	Std	<input type="checkbox"/>	<input type="checkbox"/>	<input type="checkbox"/>	<input type="checkbox"/>
1-3/8" Tread	Std	<input type="checkbox"/>	<input type="checkbox"/>		<input type="checkbox"/>
1-3/8" Solid	Std	<input type="checkbox"/>	<input type="checkbox"/>		
1-3/8" Kenda HP Tread	AD13710		<input type="checkbox"/>		
1-3/8" Knobbly V-Trak	AD13715		<input type="checkbox"/>		
1" Kenda Ironcap Blue	AD13700		<input type="checkbox"/>	<input type="checkbox"/>	
1" Kenda Konstrictor	AD13720		<input type="checkbox"/>	<input type="checkbox"/>	
1" Schwalbe Right Run	AD13740	<input type="checkbox"/>	<input type="checkbox"/>	<input type="checkbox"/>	<input type="checkbox"/>
1" Schwalbe Marathon Plus Evo	AD13750		<input type="checkbox"/>	<input type="checkbox"/>	<input type="checkbox"/>
1-3/8" Schwalbe Marathon Plus Evo	AD13751		<input type="checkbox"/>		
Custom -		<input type="checkbox"/>	<input type="checkbox"/>	<input type="checkbox"/>	<input type="checkbox"/>

PUSHRIMS

		22	24	25	26
<input type="checkbox"/> Nil					
Hard Anodised	Std	<input type="checkbox"/>	<input type="checkbox"/>	<input type="checkbox"/>	<input type="checkbox"/>
Hard Anodised 1"	AD13855		<input type="checkbox"/>		
Vinyl	AD13830	<input type="checkbox"/>	<input type="checkbox"/>	<input type="checkbox"/>	<input type="checkbox"/>
Vinyl 1"	AD13859		<input type="checkbox"/>	<input type="checkbox"/>	
Foam	AD13840	<input type="checkbox"/>	<input type="checkbox"/>	<input type="checkbox"/>	<input type="checkbox"/>
Foam 1"	AD13841		<input type="checkbox"/>		
Rubber coated (black)	AD13850	<input type="checkbox"/>	<input type="checkbox"/>	<input type="checkbox"/>	<input type="checkbox"/>
Rubber coated 1"	AD13857		<input type="checkbox"/>	<input type="checkbox"/>	
Surge Lite	AD13864	<input type="checkbox"/>	<input type="checkbox"/>	<input type="checkbox"/>	<input type="checkbox"/>
Natural Fit Lite	AD13860	<input type="checkbox"/>	<input type="checkbox"/>	<input type="checkbox"/>	<input type="checkbox"/>
<input type="checkbox"/> With thumb grip					
<input type="checkbox"/> Without thumb grip					
Max Grippe	AD13870		<input type="checkbox"/>	<input type="checkbox"/>	
Stainless Steel	AD13810	<input type="checkbox"/>	<input type="checkbox"/>	<input type="checkbox"/>	<input type="checkbox"/>
Spinergy Stainless Textured	AD13811	<input type="checkbox"/>	<input type="checkbox"/>	<input type="checkbox"/>	
Spinergy Max Stainless Textured (Ergo)	AD13812		<input type="checkbox"/>	<input type="checkbox"/>	
Q Grips	AD13865		<input type="checkbox"/>	<input type="checkbox"/>	<input type="checkbox"/>
Titanium	AD13820		<input type="checkbox"/>	<input type="checkbox"/>	<input type="checkbox"/>
Carbolife	AD13868		<input type="checkbox"/>	<input type="checkbox"/>	
<input type="checkbox"/> Curve					
<input type="checkbox"/> Curve Large					
<input type="checkbox"/> Curve Tetra					
<input type="checkbox"/> Curve Tetra Large					
<input type="checkbox"/> Gekko					
<input type="checkbox"/> Gekko S					
<input type="checkbox"/> Quadro					

PUSHRIMS - Position

<input type="checkbox"/> Std	<input type="checkbox"/> In Close	<input type="checkbox"/> On to rim
------------------------------	-----------------------------------	------------------------------------

SPOKEGUARDS

<input type="checkbox"/> Clear polycarb	AD13900	
<input type="checkbox"/> Black ABS	AD13901	
<input type="checkbox"/> Custom design (specify below)	AD13910	
Design name -		

SPARE REAR WHEELS

<input type="checkbox"/> BMX Wheels	<input type="checkbox"/> Extra Wheels
Description:	
Size:	
Tyre:	
Pushrim:	
Setting:	
To interchange with:	

Piranha Script Form

Fixed Frame Wheelchair 90400



Client Name: _____









Chair Serial No.: _____

FRAME COLOURS - For Aluminium frames









STANDARD COLOURS

						
Red 11 <input type="checkbox"/>	Blue 1 <input type="checkbox"/>	Silver 55 <input type="checkbox"/>	Black 61 <input type="checkbox"/>	Chrome 46 <input type="checkbox"/>	Black (matt) 22 <input type="checkbox"/>	Black (textured) 33 <input type="checkbox"/>

GLASS COLOURS

								
Red 29 <input type="checkbox"/>	Raspberry 83 <input type="checkbox"/>	Violet 28 <input type="checkbox"/>	Purple 16 <input type="checkbox"/>	Blue 72 <input type="checkbox"/>	Teal 17 <input type="checkbox"/>	Green 73 <input type="checkbox"/>	Shocker Yellow 67 <input type="checkbox"/>	Gold XX <input type="checkbox"/>





CANDY COLOURS

								
Candy Orange 80 <input type="checkbox"/>	Candy Red 29 <input type="checkbox"/>	Candy Raspberry 83 <input type="checkbox"/>	Candy Blue 72 <input type="checkbox"/>	Candy Teal 17 <input type="checkbox"/>	Candy Emerald 70 <input type="checkbox"/>	Candy Green 73 <input type="checkbox"/>	Candy Shocker Yellow 67 <input type="checkbox"/>	Metalic Viper 42 <input type="checkbox"/>

CANDY COLOURS (SPECIAL)

			
Glowing Aura <input type="checkbox"/>	Chameleon Sapphire <input type="checkbox"/>	Racing Raspberry <input type="checkbox"/>	Dazzling Red <input type="checkbox"/>

FLUORESCENT COLOURS

			
Fluro Green 89 <input type="checkbox"/>	Fluro Yellow 44 <input type="checkbox"/>	Fluro Orange 71 <input type="checkbox"/>	Fluro Pink 88 <input type="checkbox"/>

THIS IS A GUIDE TO COLOURS ONLY, HOW COLOURS APPEAR ON YOUR MONITOR OR WHEN PRINTED OUT MAY VARY.
 Talk to us if you want your Titanium frame coloured or polished. *Colour availability is subject to change without notice.*